

163MHz Standard Filter
Part Number 163065

Typical Performance

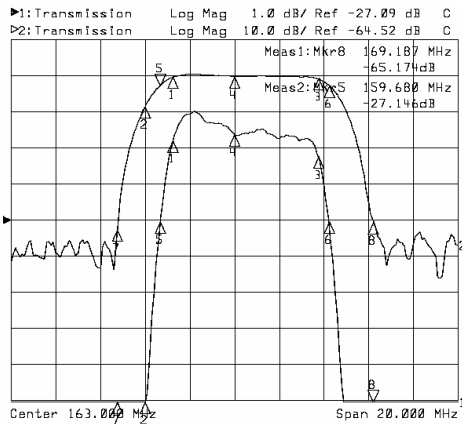

Horizontal: 2MHz/Div
 Vertical: 10dB/Div

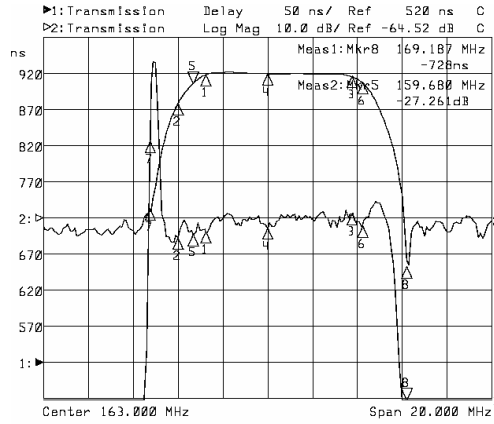

Horizontal: 2MHz/Div
 Vertical: 50nsec/Div

Specifications

Parameter	Unit	Minimum	Typical	Maximum
Center Frequency	MHz	162.90	163.00	163.10
Insertion Loss	dB		24.00	24.80
160.25MHz	dB		-0.50	-1.01
166.75MHz	dB		-1.22	-1.81
159.00MHz	dB		-10.00	-12.02
Passband Variation	dB		0.80	1.00
Group Delay Variation	nsec		50	70
Absolute Delay	usec		0.70	0.72
Ultimate Rejection	dB	38	40	
Substrate Material	-		LiTaO3	
Ambient Temperature	°C	-40	25	80

Package SFA02

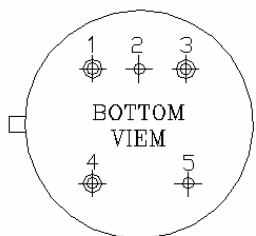
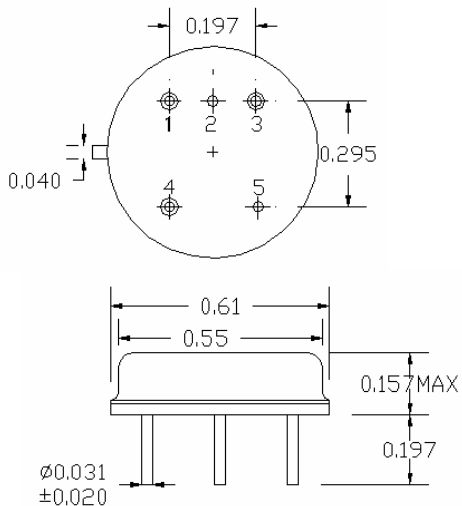

SFA02
 IN: 4
 OUT: 3
 GND: 1,2,5